

BUNN®

ULTRA-1

ULTRA-2

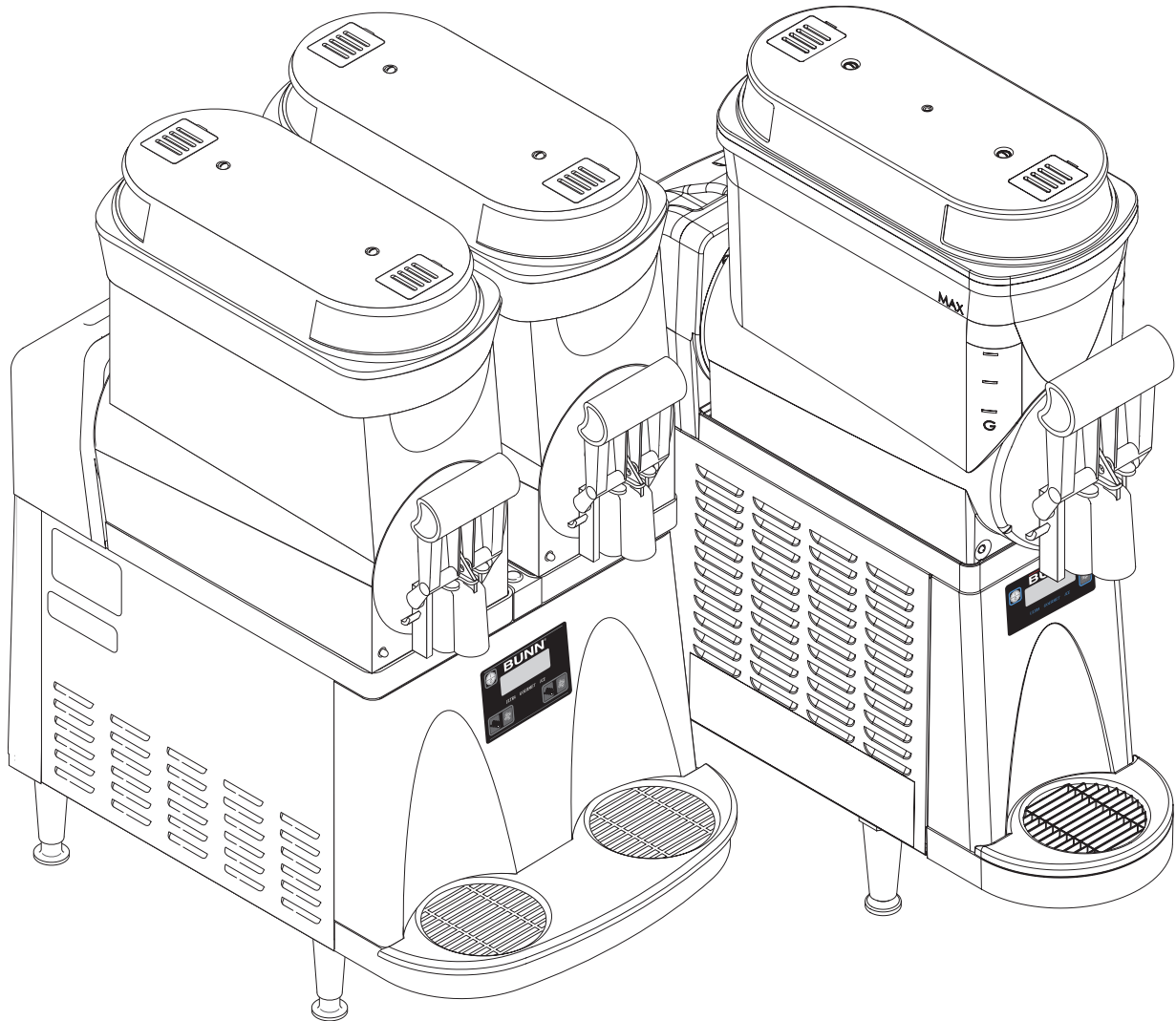

INSTALLATION & OPERATING GUIDE

BUNN-O-MATIC CORPORATION

POST OFFICE BOX 3227

SPRINGFIELD, ILLINOIS 62708-3227

PHONE: (217) 529-6601 FAX: (217) 529-6644

To ensure you have the latest revision of the Operating Manual, or to view the Illustrated Parts Catalog, Programming Manual, or Service Manual, please visit the Bunn-O-Matic website, at www.bunn.com. This is absolutely FREE, and the quickest way to obtain the latest catalog and manual updates. For Technical Service, contact Bunn-O-Matic Corporation at 1-800-286-6070.

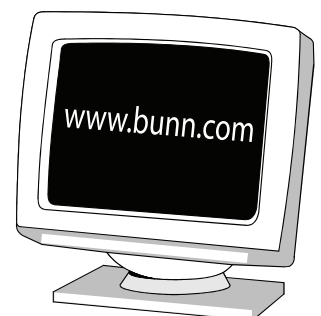

BUNN-O-MATIC COMMERCIAL PRODUCT WARRANTY

Bunn-O-Matic Corp. ("BUNN") warrants equipment manufactured by it as follows:

- 1) All equipment other than as specified below: 2 years parts and 1 year labor.
- 2) Electronic circuit and/or control boards: parts and labor for 3 years.
- 3) Compressors on refrigeration equipment: 5 years parts and 1 year labor.
- 4) Grinding burrs on coffee grinding equipment to grind coffee to meet original factory screen sieve analysis: parts and labor for 3 years or 30,000 pounds of coffee, whichever comes first.

These warranty periods run from the date of installation BUNN warrants that the equipment manufactured by it will be commercially free of defects in material and workmanship existing at the time of manufacture and appearing within the applicable warranty period. This warranty does not apply to any equipment, component or part that was not manufactured by BUNN or that, in BUNN's judgment, has been affected by misuse, neglect, alteration, improper installation or operation, improper maintenance or repair, damage or casualty. This warranty is conditioned on the Buyer 1) giving BUNN prompt notice of any claim to be made under this warranty by telephone at (217) 529-6601 or by writing to Post Office Box 3227, Springfield, Illinois 62708-3227; 2) if requested by BUNN, shipping the defective equipment prepaid to an authorized BUNN service location; and 3) receiving prior authorization from BUNN that the defective equipment is under warranty.

THE FOREGOING WARRANTY IS EXCLUSIVE AND IS IN LIEU OF ANY OTHER WARRANTY, WRITTEN OR ORAL, EXPRESS OR IMPLIED, INCLUDING, BUT NOT LIMITED TO, ANY IMPLIED WARRANTY OF EITHER MERCHANTABILITY OR FITNESS FOR A PARTICULAR PURPOSE. The agents, dealers or employees of BUNN are not authorized to make modifications to this warranty or to make additional warranties that are binding on BUNN. Accordingly, statements by such individuals, whether oral or written, do not constitute warranties and should not be relied upon.

If BUNN determines in its sole discretion that the equipment does not conform to the warranty, BUNN, at its exclusive option while the equipment is under warranty, shall either 1) provide at no charge replacement parts and/or labor (during the applicable parts and labor warranty periods specified above) to repair the defective components, provided that this repair is done by a BUNN Authorized Service Representative; or 2) shall replace the equipment or refund the purchase price for the equipment.

THE BUYER'S REMEDY AGAINST BUNN FOR THE BREACH OF ANY OBLIGATION ARISING OUT OF THE SALE OF THIS EQUIPMENT, WHETHER DERIVED FROM WARRANTY OR OTHERWISE, SHALL BE LIMITED, AT BUNN'S SOLE OPTION AS SPECIFIED HEREIN, TO REPAIR, REPLACEMENT OR REFUND.

In no event shall BUNN be liable for any other damage or loss, including, but not limited to, lost profits, lost sales, loss of use of equipment, claims of Buyer's customers, cost of capital, cost of down time, cost of substitute equipment, facilities or services, or any other special, incidental or consequential damages.

AutoPOD, AXIOM, BrewLOGIC, BrewMETER, Brew Better Not Bitter, BrewWISE, BrewWIZARD, BUNN Espresso, BUNN Family Gourmet, BUNN Gourmet, BUNN Pour-O-Matic, BUNN, BUNN with the stylized red line, BUNNlink, Bunn-OMatic, Bunn-O-Matic, BUNNserve, BUNNSERVE with the stylized wrench design, Cool Froth, DBC, Dr. Brew stylized Dr. design, Dual, Easy Pour, EasyClear, EasyGard, FlavorGard, Gourmet Ice, Gourmet Juice, High Intensity, iMIX, Infusion Series, Intellisteam, My Café, PowerLogic, Quality Beverage Equipment Worldwide, Safety-Fresh, savemycoffee.com, Scale-Pro, Silver Series, Single, Smart Funnel, Smart Hopper, SmartWAVE, Soft Heat, SplashGard, The Mark of Quality in Beverage Equipment Worldwide, ThermoFresh, 392, A Partner You Can Count On, Air Brew, Air Infusion, Beverage Bar Creator, Beverage Profit Calculator, Brew better, not bitter., BUNNSource, Coffee At Its Best, Cyclonic Heating System, Digital Brewer Control, Nothing Brews Like a BUNN, Pouring Profits, Respect Earth, Respect Earth with the stylized leaf and coffee cherry design, Signature Series, Tea At Its Best, Phase Brew, The Horizontal Red Line, Titan, trifecta, Ultra, Velocity Brew are either trademarks or registered trademarks of Bunn-O-Matic Corporation.

INTRODUCTION

This equipment dispenses granita-type and cold liquid drinks on demand from separate hoppers. Operating controls are accessible only through password protection.

CONTENTS

Warranty	2
Introduction	3
Site Preparation, Electrical Requirements	3
Initial Setup	4
Operating Controls	6
Using the Dispenser for Granita-Type Products	8
Using the Dispenser for Cold Liquid Products	8
Programming	9
Other Recommendations For Your Dispenser	13
Required Regular Maintenance	13
Recommended Daily Cleaning	14
Autofill Cleaning Instructions	16
User Notices	17

SITE PREPARATION

The dispenser is very heavy. Place it on a sturdy counter or shelf capable of supporting at least 180 lbs. It is for indoor use only.

The dispenser must have at least six inches of space behind it. This space is needed for airflow, air filter removal, and cleaning. A clearance of at approximately six inches is recommended between the dispenser sides and the wall or another appliance. The dispenser performs better if not placed near any heating appliance. Leave some space so the dispenser can be moved for cleaning.

ELECTRICAL REQUIREMENTS

CAUTION – Improper electrical installation will damage components. An electrician must provide electrical service as specified below.

Model ULTRA-1 & 2, This dispenser has an attached cordset and requires a 2-wire, grounded, individual branch circuit rated 120 volts ac, 15 amp, single phase, 60 Hz. The mating connector must be a NEMA 5-15R.

(Refer to the dataplate for exact electrical requirements.)

Model ULTRA-1A & 2A, This dispenser has an attached cordset and requires a 2-wire, grounded, individual branch circuit rated 230 volts ac, 10 amp, single phase, 50 Hz. *(Refer to the dataplate for exact electrical requirements.)*

Model ULTRA-1B & 2B, This dispenser has an attached cordset and requires a 2-wire, grounded, individual branch circuit rated 100 volts ac, 10 amp, single phase, 50 Hz. *(Refer to the dataplate for exact electrical requirements.)*

NOTE – Bunn-O-Matic does not recommend the use of any extension cord with these dispensers.

CE REQUIREMENTS

- This appliance must be installed in locations where it can be overseen by trained personnel.
- For proper operation, this appliance must be installed where the temperature is between 5°C to 35°C.
- Appliance shall not be tilted more than 10° for safe operation.
- An electrician must provide electrical service as specified in conformance with all local and national codes.
- This appliance must not be cleaned by water jet.
- This appliance is not intended for use by persons (including children) with reduced physical, sensory or mental capabilities, or lack of experience and knowledge, unless they have been given instructions concerning use of this appliance by a person responsible for its safety.
- Children should be supervised to ensure they do not play with the appliance.
- If the power cord is ever damaged, it must be replaced by the manufacturer or authorized service personnel with a special cord available from the manufacturer or its authorized service personnel in order to avoid a hazard.

INITIAL SETUP

CAUTION – The dispenser is very heavy! Use care when lifting or moving it. Use at least two people to lift or move the dispenser.

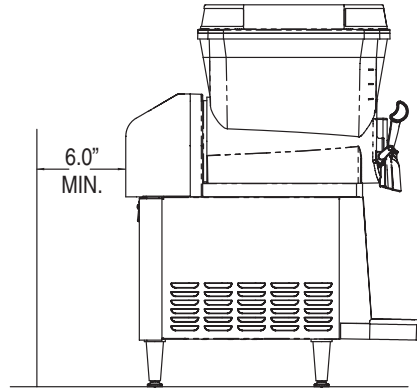

1. Set the dispenser on a sturdy counter top. The dispenser requires a minimum of 6.0" air clearance at the rear of the dispenser. For optimum performance, **do not** let warm air from surrounding machines blow on the ULTRA dispenser.

NOTE – The dispenser should be level or slightly lower in front for proper operation.

2. Remove all shipping material, including the compressor support eyebolt, the cooling drum supports, the "Do Not Lift Here" signs from the cooling drums, and the "Rinse Before Using" signs from the hopper(s). **For models without PAF (Powder Auto-Fill), proceed to step #7.**

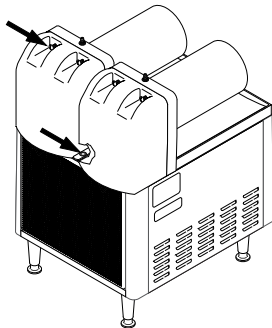

3. Remove the rear plastic plug from the trim strip between the hopper drip trays and loosen the auger motor cover screws.

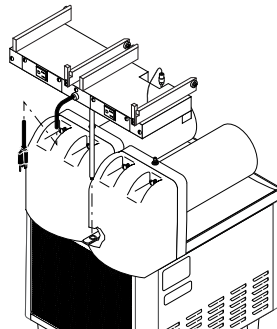

4. Place PAF platform assembly on top of the motor covers and install support rod into hole in trim strip.

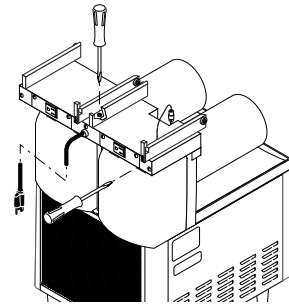

5. Tighten support rod from top of platform. Retighten motor cover screws.

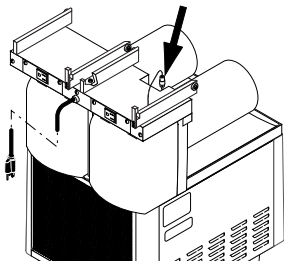

6. Plug RCA cord into ULTRA base unit. Proceed with steps 7 thru 12.

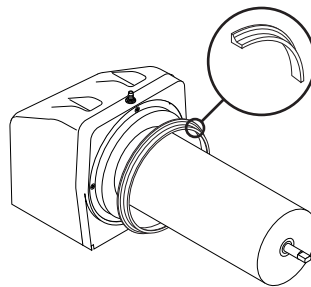

7. Install each hopper seal over the flange at the rear of the cooling drums as shown.

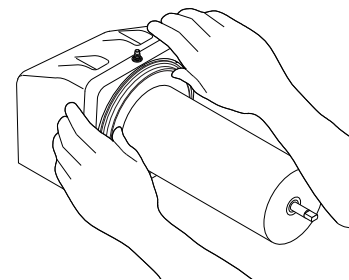

8. Press the seals firmly into place.

INITIAL SETUP (CONT.)

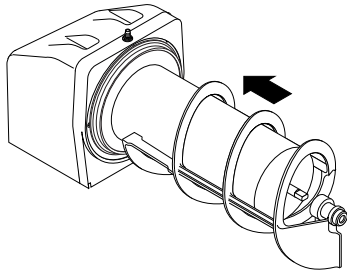

- 9.** Align the auger shaft with the flat fin of the auger. Push the augers as far as they will go and rotate them so the flat fin is facing up.

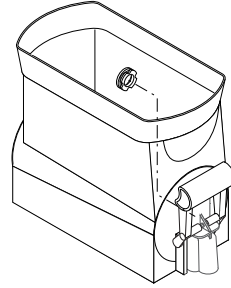

- 10.** Install auger nose bushing into inside front of hopper.

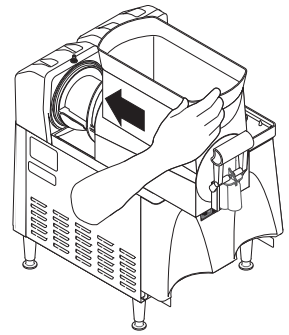

- 11.** Thoroughly rinse the hoppers and install them over the augers and cooling drums.

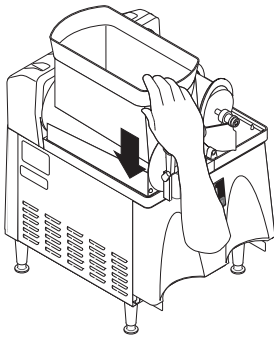

- 12.** Slide the hopper(s) into place and push down until the hopper lock plunger snaps into place. For models without PAF, proceed to step 15.

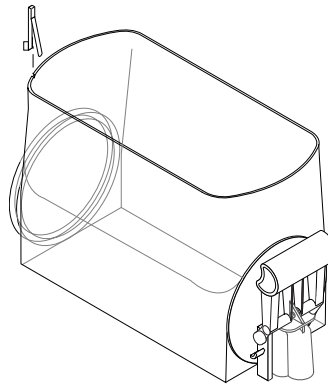

- 13.** For models with PAF, install level probes into slots at top rear of PAF hoppers.

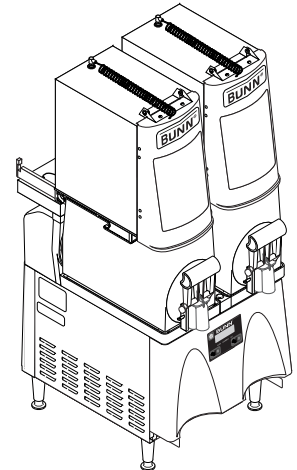

- 14.** Install PAF unit onto platform and plug power cord into rear of platform. Plug platform power cord into proper outlet. (Refer to PAF manual for water connections)(Proceed to step 17)

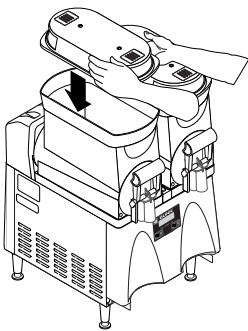

- 15.** Set the lid(s) on the hopper(s). Lift slightly and slide back or front for filling.

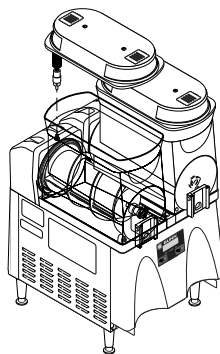

- 16.** Plug in the hopper lid lamp cord(s).

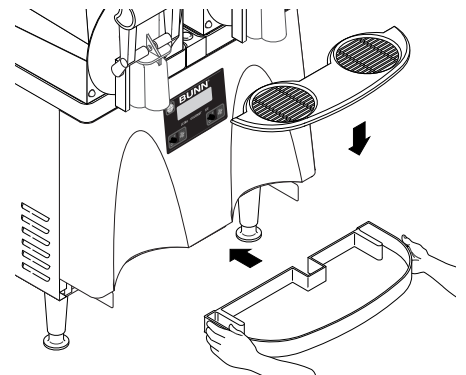



- 17.** Assemble the drip tray.

OPERATING CONTROLS ULTRA-1

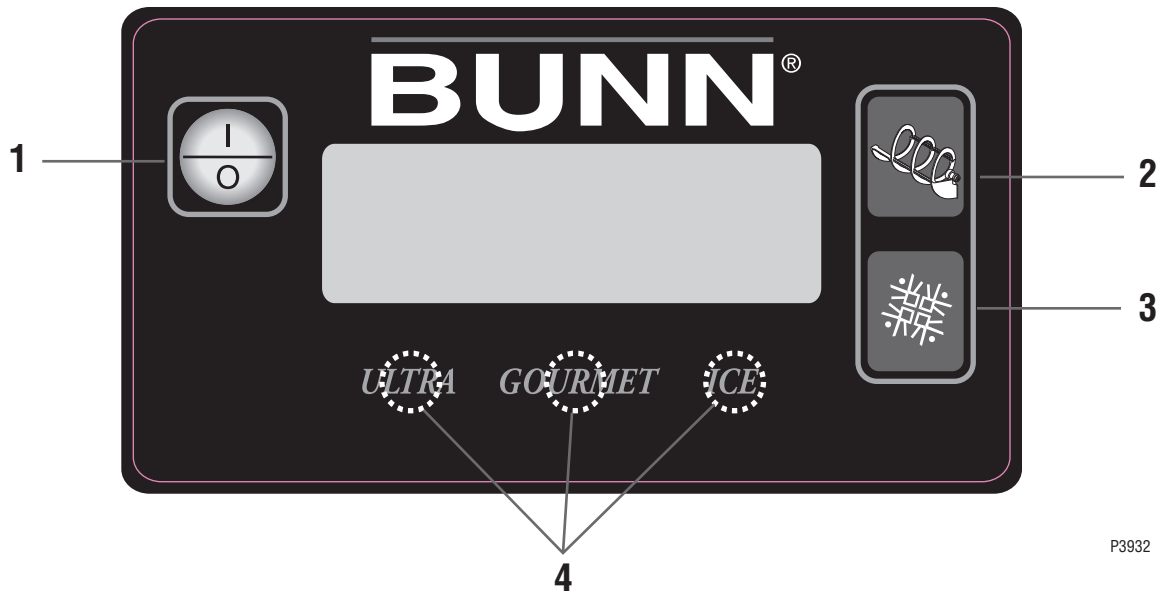
There are three of these switches that will be used for the operation of the dispenser.





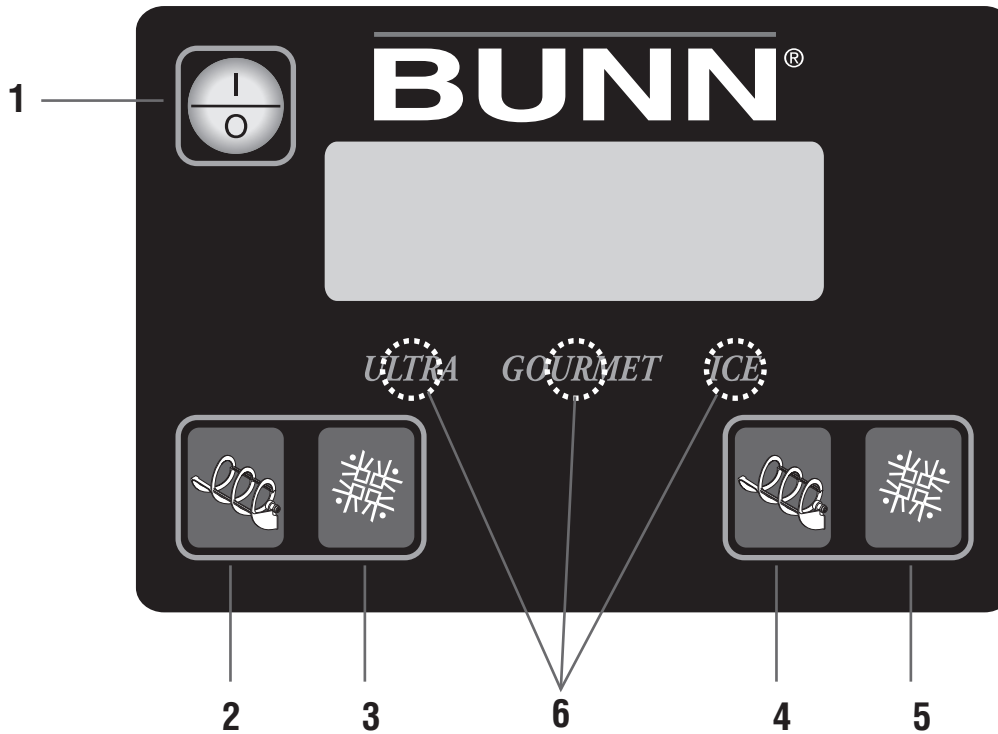

-  switch (upper left corner of the control pad)
This switch is the ON/OFF toggle switch which powers up the dispenser and the LCD display. When ON the Date and Time toggle back and forth continuously except during programming.
-  (upper right corner)
This is used to turn the auger motor to AUGER ON, AUGER OFF or AUGER REFILL ON. (Refill only applicable when installed)
-  (lower right corner)
This is used to turn the ice control to OFF, ICE or CHILL.
- Hidden buttons used for Programming.

OPERATING CONTROLS ULTRA-2



There are five of these switches that will be used for the operation of the dispenser.



P3677



-  switch (upper left corner of the control pad)
This switch is the ON/OFF toggle switch which powers up the dispenser and the LCD display. When ON the Date and Time toggle back and forth continuously except during programming.
-  (bottom left corner)
This is used to turn the left side auger motor to AUGER ON, AUGER OFF or AUGER REFILL ON. (Refill only applicable when installed)
-  (bottom left corner)
This is used to turn the left side ice control to OFF, ICE or CHILL.
-  (bottom right corner)
This is used to turn the right side auger motor AUGER ON, AUGER OFF or AUGER REFILL ON. (Refill only applicable when installed)
-  (bottom right corner)
This is used to turn the right side ice control to OFF, ICE or CHILL.
- Hidden buttons used for Programming.

USING THE DISPENSER FOR GRANITA-TYPE PRODUCTS

1. Lift the lid slightly for the selected hopper and slide back to gain access to the hopper.
2. Place the pre-mixed liquid product in the selected hopper.
3. a. Press and release the  (ON/OFF) switch to power on the dispenser.
b. Press and release the appropriate  (ON/OFF) switch to start the Auger Motor and to turn on AutoFill when applicable.
c. Press and release the  (OFF/**ICE**/CHILL) switch and select ICE to begin the cooling process for the selected hopper.
4. Wait for the liquid to freeze to the desired consistency.

HINTS – Bunn-O-Matic recommends that the product in the dispenser be thawed each day, usually overnight. The ice granules get too large and a consistent product is difficult to maintain if left frozen for an extended period of time. Set the NIGHT mode for a few hours each night and return it to the DAY mode when the product has thawed sufficiently. You'll know it is in the NIGHT mode because the display will indicate NIGHT MODE, and the hopper light(s) will turn off.

USING THE DISPENSER FOR COLD LIQUID PRODUCTS

1. Lift the lid slightly for the selected hopper and slide back to gain access to the hopper.
2. Place the pre-mixed liquid product in the selected hopper.
3. a. Press and release the  (ON/OFF) switch to power on the dispenser.
b. Press and release the appropriate  (ON/OFF) switch to start the Auger Motor and to turn on AutoFill when applicable.
c. Press and release the  (OFF/ICE/**CHILL**) switch and select CHILL to begin the cooling process for the selected hopper.
4. Wait for the liquid to cool.

PROGRAMMING

Using the menu-driven display on the front of the dispenser, the operator has the ability to alter or modify various parameters such as beverage consistency and set day/night “ON/OFF” times. The operator is also prompted to check a variety of periodic service functions or even a step-by-step cleaning routine. There is also the opportunity to return all changes back to factory default settings.

Access to most controls can be password protected to allow only qualified personnel to make changes.

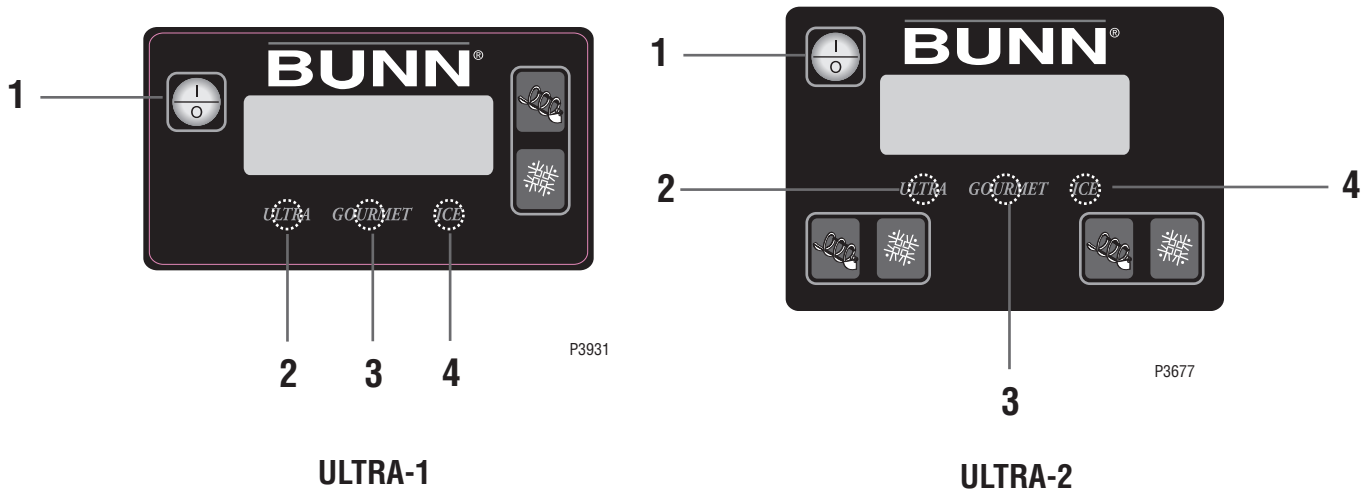

PROGRAMMING SWITCHES

To access the programming mode, and to scroll through the different function screens, hidden programming switches are used. There are three of these switches that will be used for the setup of the dispenser.

1. **I/O** switch (upper left corner of the control pad)

This switch is the ON/OFF toggle switch which powers up the dispenser and the LCD display. This switch is also used as back up switch in menu mode.

2. **“ULTRA”** (left under display)

When prompted by a selection from the menu to answer yes or no, the “ULTRA” switch is used to answer “NO” or (-) minus.

3. **“GOURMET”** (center under display)

Press and hold this switch 5 seconds to access the Menu Function Index. This switch is also used as “NEXT” to scroll through the functions.

4. **“ICE”** (right under display)

When prompted by a selection from the menu to answer yes or no, the “ICE” switch is used to answer “YES” or (+) plus.

PROGRAMMING THE DISPENSER

During normal operations, the Date, the Time, and the Serial Number toggle back and forth continuously. The following function screens are in the order they appear from the menu display. Each screen will have instructions and procedures to program the various functions of the dispenser.

HOME SCREEN

Displays the TIME, DATE, SERIAL NUMBER and ASSET NUMBER which toggle back and forth continuously.

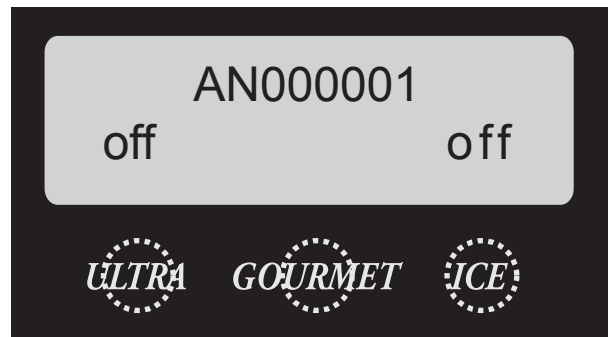
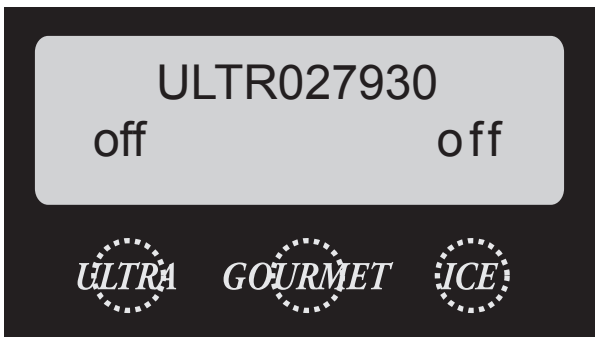
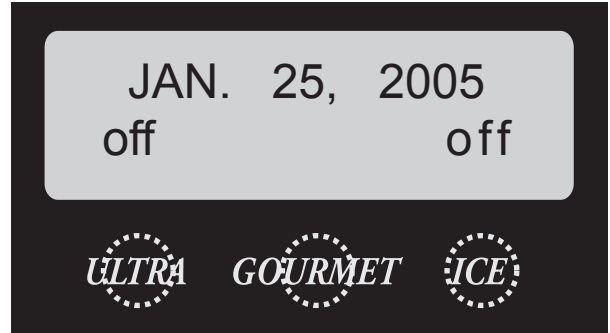
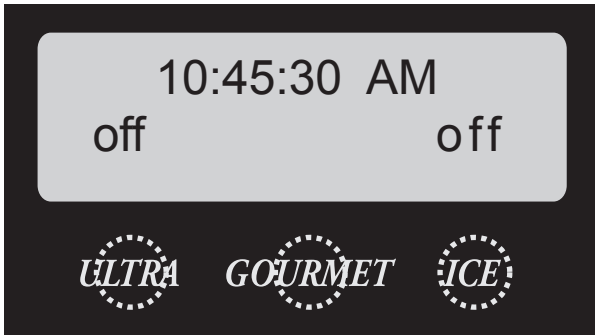

MENU FUNCTION INDEX

Press and hold for five seconds the GOURMET hidden switch to enter into the Menu Function Index. The screens on the following page are in order that they appear from the menu display. Pressing NO ("ULTRA") or NEXT (GOURMET") will advance to the next function. Press ON/OFF ("I/O") will back up to the previous screen. A one minute time out will return to the Home Screen.

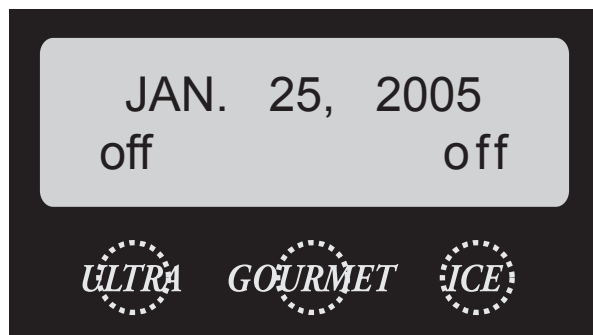

P3678

PROGRAMMING THE DISPENSER (Cont.)

Set Consistency

This function allows the operator to adjust the ice consistency, or torque of each auger when answered YES ("ICE"). Two screens will appear for left and right. The operator can scroll through a range of a minimum of 1 (ULTRA) to a maximum of 16 (ICE). Factory default is 10.

NOTE: ULTRA-1 models will only have one adjustment screen.



P3678

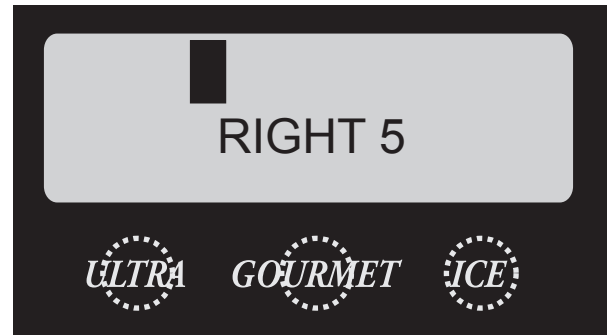
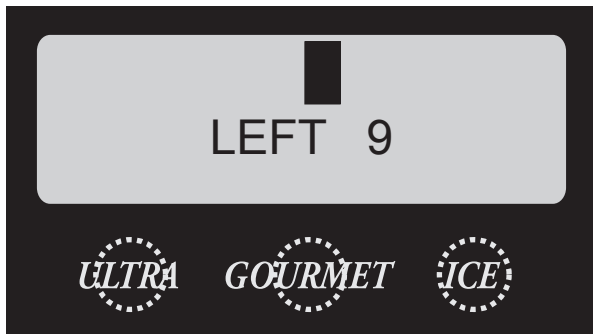

Set Time and Date

Selecting YES (ICE) allows the operator to set the DATE (YY MM DD) and TIME (HR MIN SEC) for display on the Home Screen.

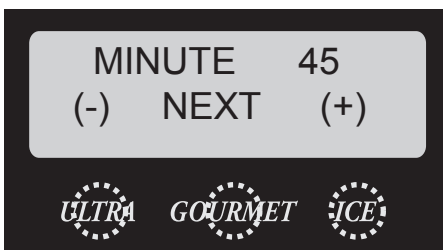
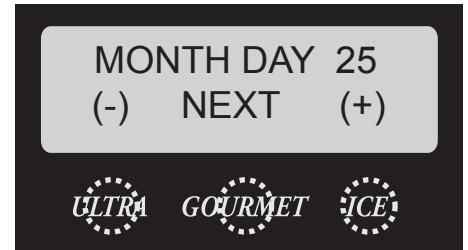
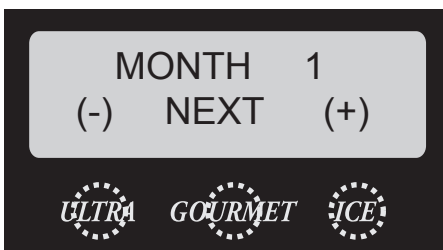

PROGRAMMING THE DISPENSER (Cont.)

Set Night Time/Set Day Time

The setting of the Day/Night mode allows the dispenser to “power down” during off hours. The bottom corners displaying “ICE” will change to “CHILL” during the night mode. During the night mode, the product will be kept chilled to below 35°F. “ICE” reading will return after night mode elapses. With “OFF” representing 12:00 AM, the operator can scroll to the times desired for the night time mode to begin and end.



Install Date

The following three screens will scroll after advancing past the function “Restore Defaults”. The Install Date and Time is recorded when the dispenser is powered on for the first 100 hours. The Install Date and Time cannot be reset and is stored in permanent memory.

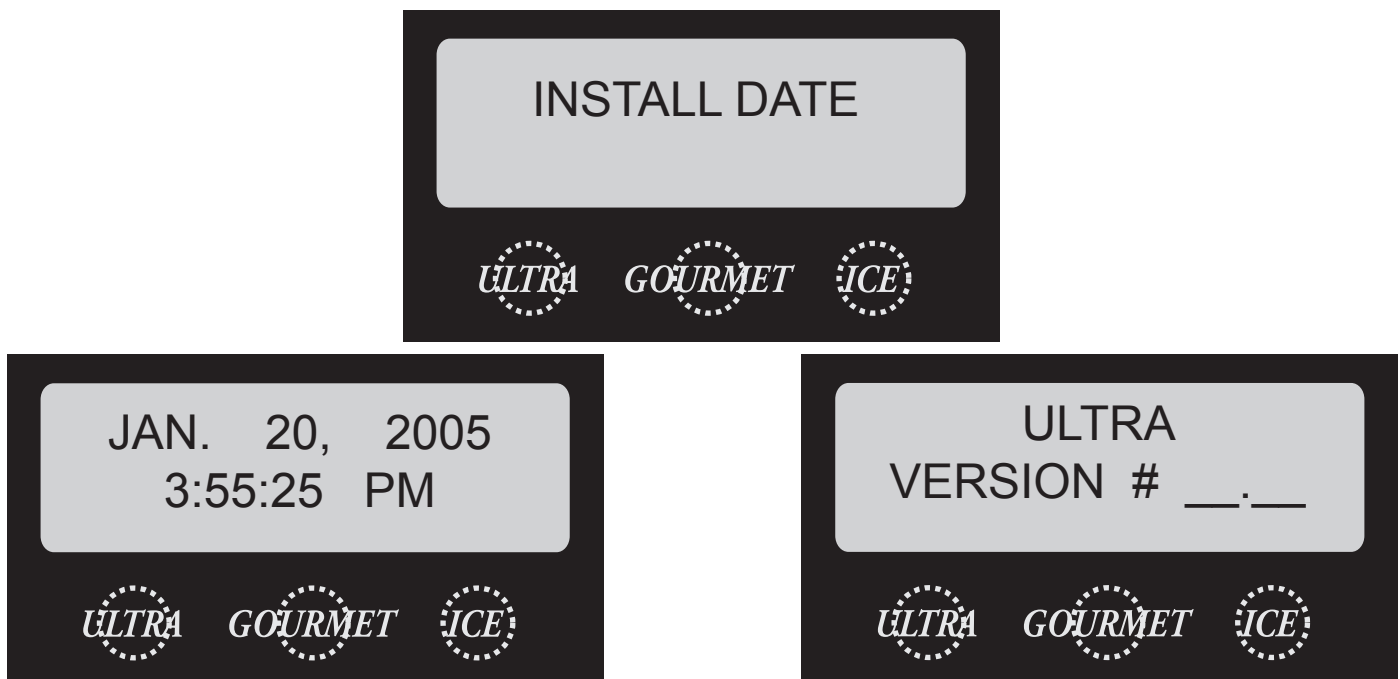

NOTE: Several other menu functions are included in this dispenser. Please refer the Programming Manual available on the Bunn website at www.bunn.com

OTHER RECOMMENDATIONS FOR YOUR DISPENSER

- Whether liquid concentrate or granulated powder, all product must be thoroughly mixed BEFORE adding it to the hoppers.

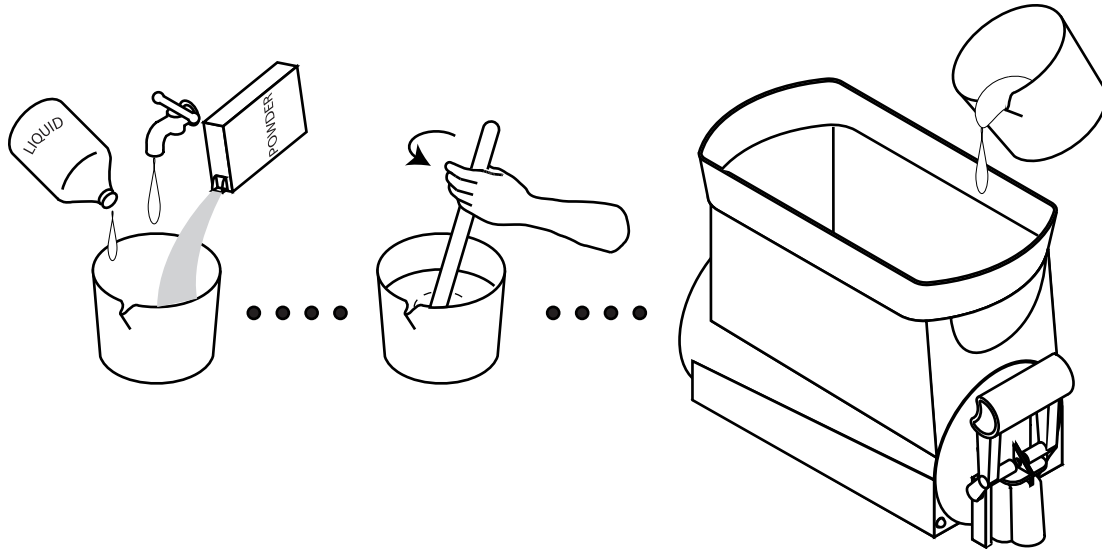

- For best results with granita-type products, use only products with an apparent brix of 12 or higher. Some products may work with an apparent brix as low as 9. Your experimentation with other products will be the best guide in this area.
- Keep the pre-mixed liquid product refrigerated. This reduces cooling/freezing time in the dispenser.
- Keep the hoppers topped-off during peak serving periods. Add pre-mixed liquid product as it is dispensed. This reduces the cooling/freezing time and assures you of always having product ready to dispense.
- Keep the product level in the hoppers higher than the auger. If the auger is exposed, air will become entrapped in the mixture resulting in a clouded foamy consistency.
- You may find it beneficial to turn down the ice controls to keep the ice granules from growing too large. Refer to *Programming The Dispenser* on page 10 for Setting the Consistency.
- Some products freeze at a lower temperature than others. You may notice frost or ice on the hoppers. This is normal and should not be a concern.
- Humidity in the air may cause sweating on the outside surfaces of the hoppers. This is to be expected and should not be a concern. The drip trays beneath the hoppers will capture this and cause it to flow to the lower drip tray for disposal.
- Some noises are to be expected during normal operation of the dispenser. By becoming familiar with the noises made during normal operation, you will be better able to listen for problems.

PREVENTIVE MAINTENANCE

Bunn-O-Matic® Corporation recommends that preventive maintenance be performed at regular intervals. Maintenance should be performed by a qualified service technician. For Technical Service, contact Bunn-O-Matic® Corporation at 1-800-286-6070.

NOTE: Replacement parts or service caused by failure to perform required maintenance is not covered by warranty.

Cycle (months)	Item
6	Replace hopper drum seal.
6	Replace faucet seal.
6	Inspect auger shaft for abnormal wear.
6	Replace the auger shaft bushing
6	Replace the cooling drum seal.
6	Lubricate the motor shaft and motor shaft groove.
monthly	Clean condenser air filter.
6 or as needed	Clean condenser coil.
6 or as needed	Inspect and clean the condenser fan.
6	Inspect, clean, or replace the hopper tray drain tubes.

RECOMMENDED DAILY CLEANING (ULTRA-2 shown)

1. Turn cooling to OFF selection. Empty all product from the hopper(s). Turn auger to OFF selection. Disconnect the hopper lid lamp cord(s) and remove the lids. On models with autofill, disconnect fill hoses and level probe from hopper.

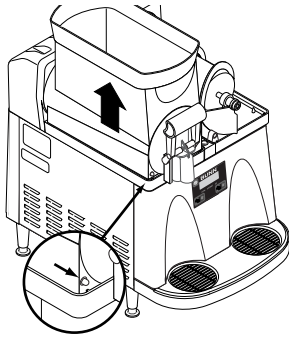

2. Depress the hopper lock plunger. Lift the hopper up slightly.

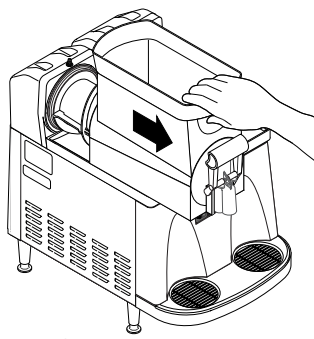

3. Pull forward to remove.

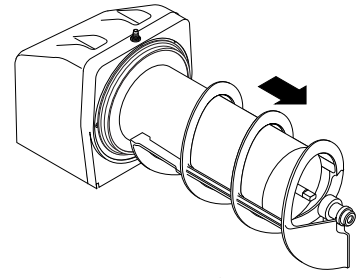

4. Pull the auger from the cooling drum.

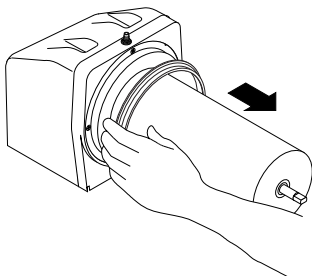

5. Remove the cooling drum seal from the rear of the drum.

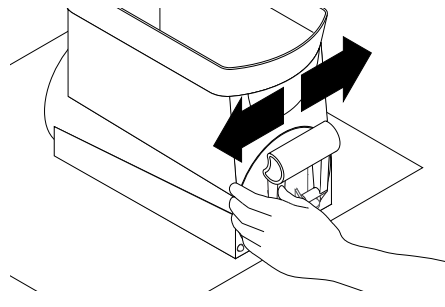

6. **Caution:** The faucet valve is under spring tension. Spread one side of the handle first, then the other and disconnect from the hopper.

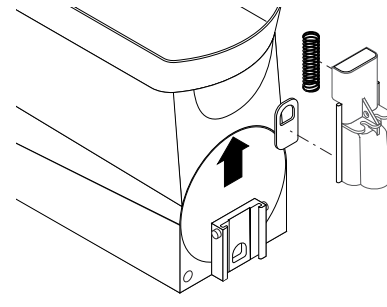

7. Carefully slide the faucet valve up to remove the spring and faucet seal. Extra care should be taken when handling the seal to prevent damage. Do not fold the seal as this will cause damage to the Teflon[®] sealing surface.

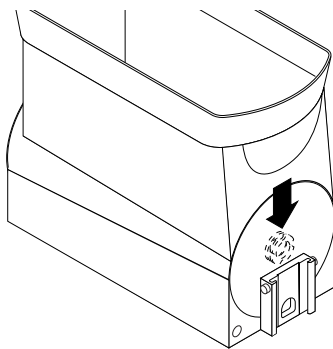

8. Remove the auger nose bushing from inside the hopper.

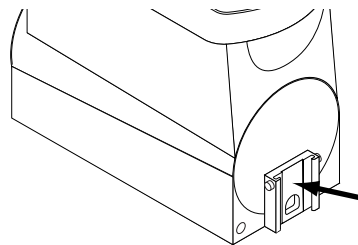

9. Care must be taken to ensure this surface does not get scratched during cleaning. Deep scratches could cause leakage around the seal.

10. Place all parts in a clean sink with mild hot water (120°F) and sanitizer solution. Allow all parts to soak for at least 5 minutes. Carefully wash all components with a clean wash cloth in the hot water and sanitizer solution. Use a clean, soft bristle brush as needed for the smaller components and tight areas. **Do not immerse hopper lids.** Use a commercial sanitizer that has 100 ppm of available chlorine with a concentration level of at least 3% available chlorine (KAY-5 Sanitizer). Follow the sanitizer's mixing instructions to ensure 100 ppm of available chlorine.

11. Wash the drums, hopper drip trays, top covers, and outer enclosure using a clean wash cloth that has been dampened in the hot water and sanitizer solution. Pay particular attention to the shaft area and make sure it is thoroughly cleaned and sanitized.

12. Thoroughly rinse all surfaces with a clean wash cloth that has been dampened with hot water. Wipe dry with a clean dry wash cloth before reassembling the dispenser.

NOTE – Although most parts are dishwasher safe, they may be affected by the chemicals in some commercial sanitizing agents. Do not place the hopper nor hopper lids in a dishwasher. Rinse thoroughly before assembly.

ASSEMBLY FOLLOWING CLEANING

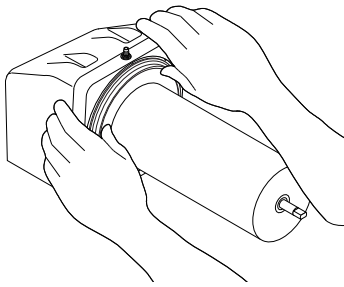

1. Install the seal(s) over the flange at the rear of the cooling drum(s) and press the seal(s) firmly into place as shown.

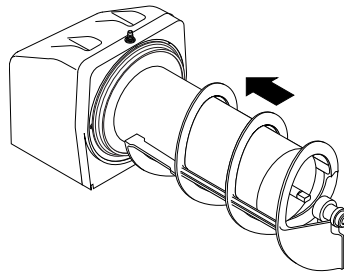

2. Align the auger shaft(s) with the auger(s). Push the auger(s) as far as they will go and rotate so the flat face of the auger shaft is aligned with the flat face of the auger nose.

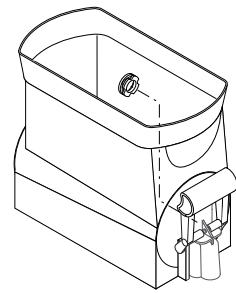

3. Install auger nose bushing into inside front of hopper.

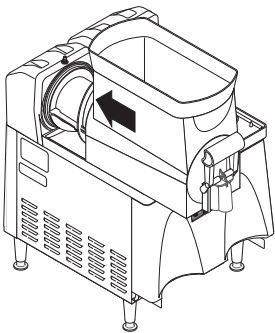

4. Thoroughly rinse the hopper(s) and install over the auger(s) and cooling drum(s).

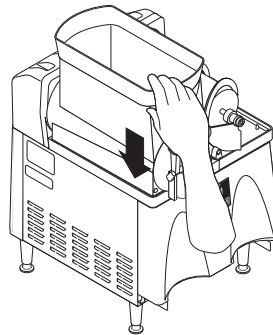

5. Slide into place and push down until the hopper lock plunger(s) snap into place. On models with autofill, reconnect fill hoses and level probe to hopper.

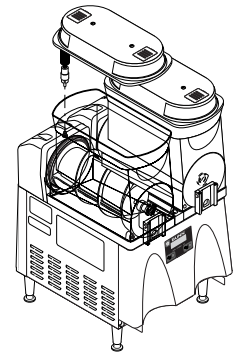

6. Set the lids on the hopper(s) and plug in the hopper lid lamp cord(s).

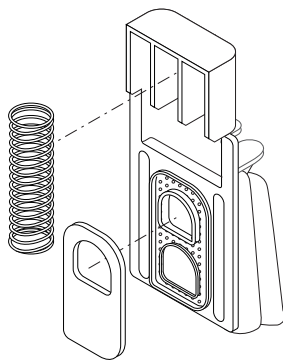

7. Position the faucet seal and return spring in the faucet valve.

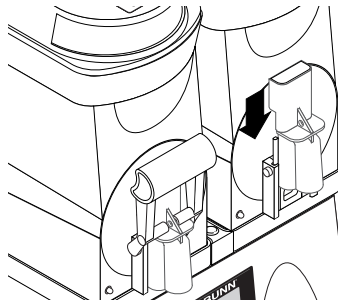

8. Slide the faucet valve assembly into place on the hopper.

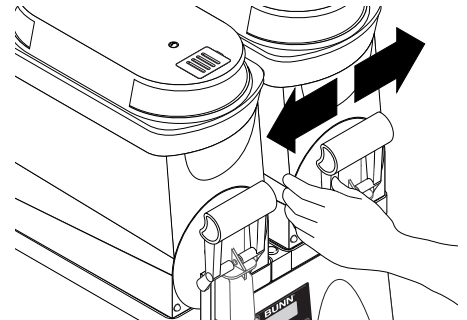

9. Press down on the valve to compress the spring. Position the faucet handle over the faucet valve one side at a time and snap into place on the hopper.

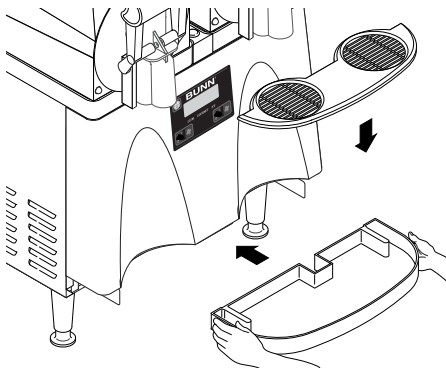

10. Assemble the drip tray.

11. Turn ON augers and cooling function to desired settings.

Auto-fill Cleaning Instructions (With Brixing Pump Installed)

Materials required

1. Non-sudsing liquid detergent (such as common household automatic dishwasher liquid detergent).
2. Household bleach (Sodium chloride solution: 5.25%) or equivalent.
3. Clean five (5) gallon bucket.
4. Measuring Cup
5. An adaptor is needed to hold the Q.C.D. (Quick Connect/Disconnect) fitting on the concentrate suction line open. A connector from an empty bag will work.

Sanitizing Procedure

1. Fill bucket with 4 gallons of warm water (120-180 deg. F).
2. Measure 4 ounces (1/2 cup) of the liquid detergent and add to the water.
3. Measure 2 ounces (1/4 cup) of bleach and add to the water, then stir, mixing evenly.
4. Ensure that the refill for the Ultra hopper is turned off.
5. Empty all product from the Ultra hopper
6. Disconnect the concentrate line from the B-I-B and install adaptor on the quick disconnect so the line is open to the sanitizing solution. Place concentrate inlet line into the bucket so that the Q.C.D. will stay at the bottom.
7. Press the auger button to turn on the "Auger Refill On" feature.
8. Allow system to run until the hopper is about 1/4 full then turn off refill.
9. Switch three way sanitize valve to the Sanitize position.
10. Turn refill system back on and let run until the hopper is almost full then turn off refill.
11. Allow sanitizer to sit in system for 10 minutes.
12. Drain sanitizer from hopper and remove the Q.C.D. from the sanitizer bucket.
13. Empty remaining sanitizer and refill bucket with about 2 gallons of warm (120-180 deg. F) rinse water.
14. Turn sanitize valve back to dispense position.
15. Place Q.C.D. into rinse water and turn on refill system.
16. Run until hopper is about 1/4 full.
17. Turn off refill system and drain hoppers.
18. Refer to the *Recommended Daily Cleaning* instructions and follow these steps to clean the hopper, lid and other dispense parts.

USER NOTICES

Carefully read and follow all notices on the equipment and in this manual. They were written for your protection. All notices are to be kept in good condition. Replace any unreadable or damaged labels.

 WARNING	
<p>Moving Parts.</p> <p>Do not operate unit with this panel removed.</p>	<p>Risk Of Electrical Shock.</p> <p>Disconnect power before servicing unit.</p>

27442.0000

 CAUTION
<p>Risk of Electric Shock.</p> <p>This equipment may have two power supply cords. Unplug all cords before moving or servicing this equipment.</p>

29947.0000

 WARNING
<ul style="list-style-type: none"> • DO NOT OVERLOAD CIRCUIT. • ALWAYS ELECTRICALLY GROUND THE CHASSIS OR ADAPTOR PLUG. • DO NOT DEFORM PLUG OR CORD. • FOLLOW NATIONAL AND LOCAL ELECTRICAL CODES. • KEEP COMBUSTIBLES AWAY.
<p>FAILURE TO COMPLY RISKS EQUIPMENT DAMAGE, FIRE OR SHOCK HAZARD.</p>
<p>READ THE ENTIRE OPERATING MANUAL BEFORE USING THIS PRODUCT</p> <p><small>00986.0002E 5/98 ©1994 Bunn-O-Matic Corporation</small></p>

00986.0002

CHARGE
<p>Type R404A, Amount 10 oz</p> <p>Design Pressures: High 430 Low 80</p>

32162.0000 (ULTRA-2)

CHARGE
<p>Type R404A, Amount 9.5 oz (269 gm)</p> <p>Design Pressures:</p> <p>High 215 psi (15 bar) (1.48 MPa)</p> <p>Low 40 psi (3 bar) (0.28 MPa)</p>

29373.0000 (ULTRA-2A)

CHARGE
<p>Type R404A, Amount 6 oz (170 gm)</p> <p>Design Pressures:</p> <p>High 330 psi (23 bar) (2.75 MPa)</p> <p>Low 60 psi (4 bar) (0.41 MPa)</p>

32162.0001 (ULTRA-1)

<p>INTENDED FOR USE AT A ROOM TEMPERATURE OF 27°C (80°F)</p>

29979.0000