



1250 Victoria St, Carson, CA 90746
 Tel. 310-900-1000 Fax. 310-900-1077
 www.turboairinc.com

Project :

Model # :

Item # :

Qty :

Available W/H :

Approval :

Manual Control High Efficiency Counter Top Griddles

Model : TAMG-



TAMG-12



TAMG-24



TAMG-36



TAMG-48

≡ FEATURES / BENEFITS ≡

- STAINLESS STEEL FRONT, SIDE AND 4" FRONT TOP LEDGE.
- 4" BACKSPLASH WITH TAPERED SIDE SPLASHES.
- 3" WIDE STAINLESS STEEL FRONT GREASE TROUGH.
- ONE 22,000 BTU/HR U SHAPED ALUMINIZED BURNER FOR EVERY 12" OF GRIDDLE WIDTH.
- ERGONOMICALLY DESIGNED HEAT RESISTANT PPS ON-OFF KNOB.
- 3/4" POLISHED STEEL GRIDDLE PLATE.
- ADJUSTABLE STAINLESS STEEL STANDING PILOT FOR EACH BURNER.
- HIGH EFFICIENCY GRIDDLE WILL PROVIDE FASTER COOKING AND RECOVERY BUT AMAZINGLY USE APP. 25% LESS GAS THAN TYPICAL GRIDDLE.
- 3/4" REAR GAS CONNECTION AND GAS PRESSURE REGULATOR.
- 2" STAINLESS STEEL LEGS INCLUDED.
- AVAILABLE IN 12", 24", 36" AND 48" WIDE.
- A FULL ONE YEAR LIMITED PARTS AND LABOR WARRANTY.



Model	Control	#of Burners	Total BTUs	Crated Weight (lbs.)	W x D x H*(inches)	Plate Depth
TAMG-12	Manual	1	22,000	136	12 x 30 1/2 x 12 1/2	22
TAMG-24	Manual	2	44,000	220	24 x 30 1/2 x 12 1/2	22
TAMG-36	Manual	3	66,000	302	36 x 30 1/2 x 12 1/2	22
TAMG-48	Manual	4	88,000	386	48 x 30 1/2 x 12 1/2	22

Manual Control High Efficiency Counter Top Griddles

Model : TAMG-

GAS DATA	
Gas Type	NAT/LP Convertible
Gas Connection	3/4"
Regulator	3/4"
SHIPPING DATA	
Class	85
Width (in.)	16 / 28 / 40 / 52
Depth (in.)	32
Height (in.)	19
Shipping Weight (lbs.)	136 / 220 / 302 / 386

Design and specifications subject to change without notice.
Actual shipping weight may differ due to extra packing materials for product protection.

■ **WARRANTY : 1 Year Labor and Parts Warranty**

Ver.201203

PLAN VIEW

(unit : inch)

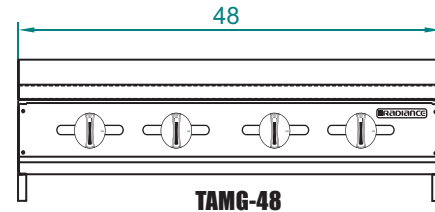
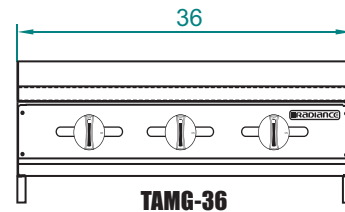
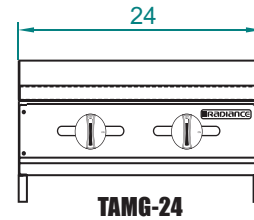
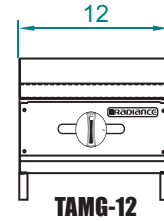

FRONT VIEW

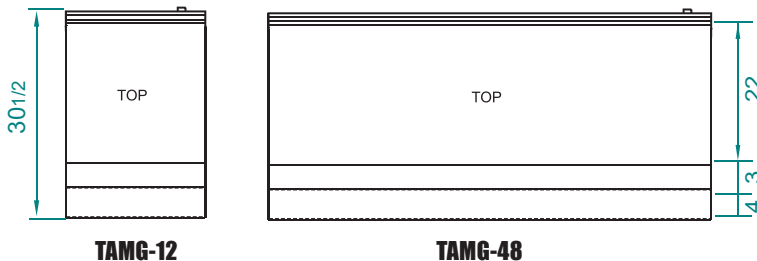
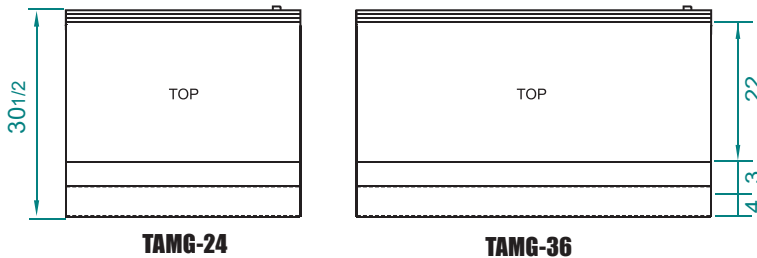

TOP VIEW

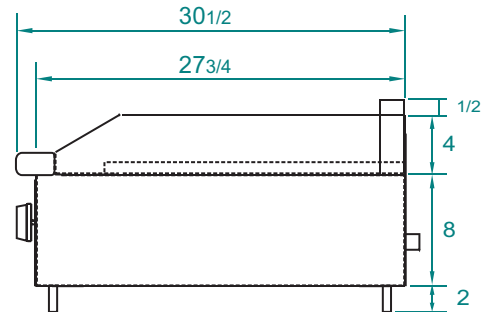

SIDE VIEW



- Turbo Air : 800-627-0032 ■ GK : 800-500-3519
- Warranty : 800-381-7770 ■ AC : 888-900-1002