



Instruction Manual

Open Merchandisers

Models: 3OM
6OM



3OM



6OM

124 Norfinch Dr. Toronto, ON. M3N 1X1
Tel : 416-663-3051 Fax : 416-663-5793
Toll Free : 1-888-408-8819

 **IGLOO**
REFRIGERATION LTD.

Contents

1 UNLOADING	3
2 PROPERTIES OF THE UNIT.....	3
2.1. Purpose	3
2.2. Description of the unit.....	3
2.3. Technical data	5
3. PREPARING THE DEVICE FOR START UP	5
3.1. Installation requirements	5
3.2. Unit Location	6
3.3. Connection and start-up	6
4. UNIT START UP	8
4.1. Temperature regulation	9
5. MAINTENANCE	9
5.1 Cleaning and maintenance	13
6. SERVICE	14
6.1 Faults identification and repair	14
6.2 Service	15

List of Figures

Figure 1 “3OM” overview	4
Figure 2 “6OM” overview	4
Figure 3 Permanent connection	6
Figure 4 Fixing the hook in the frame	7
Figure 5 Rack shelf set	7
Figure 6 Light plug	7
Figure 7 Control panel.....	8
Figure 8 “Carel” thermostat control panel	9
Figure 9 Cleaning the condenser	13

List of Tables

Table 1 Technical data -3OM.....	5
Table 2 Technical data -6OM.....	5
Table 3 Table of alarms and signals	10
Table 4 Table of easy compact parameters for Model 3OM and 6OM	11

1 UNLOADING

The unit should be transported in vertical position and properly secured and packed.

2 PROPERTIES OF THE UNIT

2.1. Purpose

“30M” and “60M” units are universal cooling devices aimed for storing and displaying a vast range of grocery products. Products must be cooled to storing temperature before displaying them in the unit. The temperature inside the display cabinet equals +1°C/+4°C with ambient temperature of +15°C/+25°C and relative air humidity up to 60%, depending on the environment of the unit location.

2.2. Description of the unit

“30M” and “60M” display cabinets have dynamic cooling.

These display cases are equipped with automatic defrosting and automatic condensate evaporation.

These units are adjusted and can be connected in sequence in the version with self-contained compressors.

Racks are equipped with 3 display shelves with the possibility to change their height and angle.

The interior of the rack is illuminated. It is also possible to add additional illumination on each shelf.

Our equipment is manufactured in accordance to modern technologies and has all certificates required by law.

The description in this box signifies important information for user security and for proper operation of the device.

Figure 1 "3OM" overview

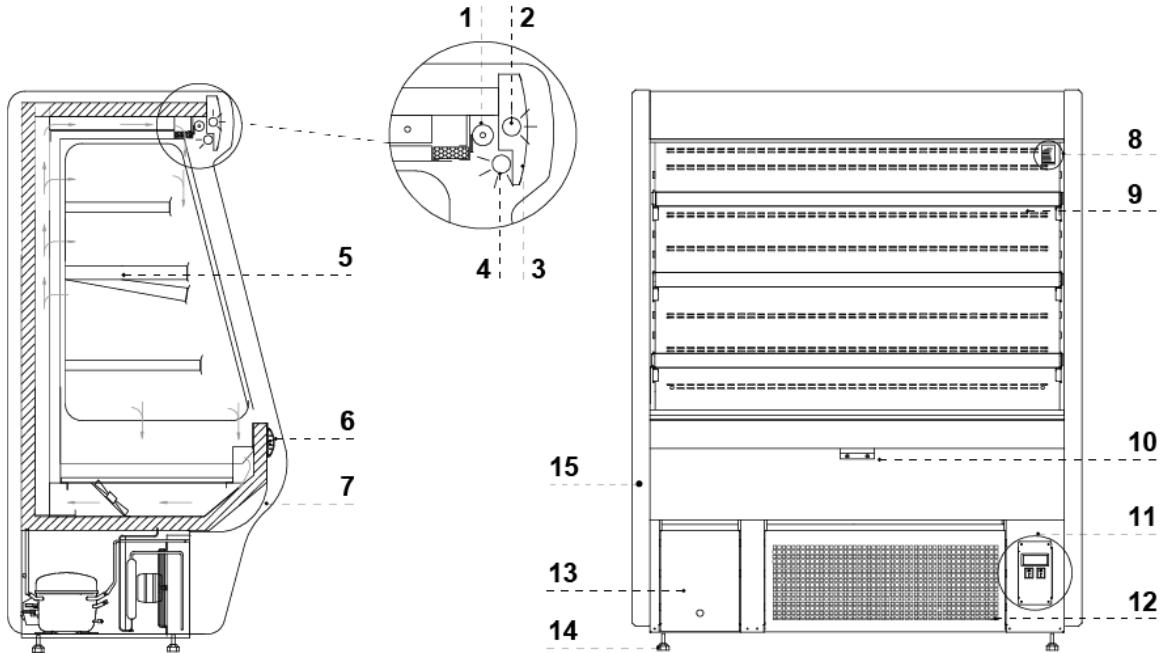
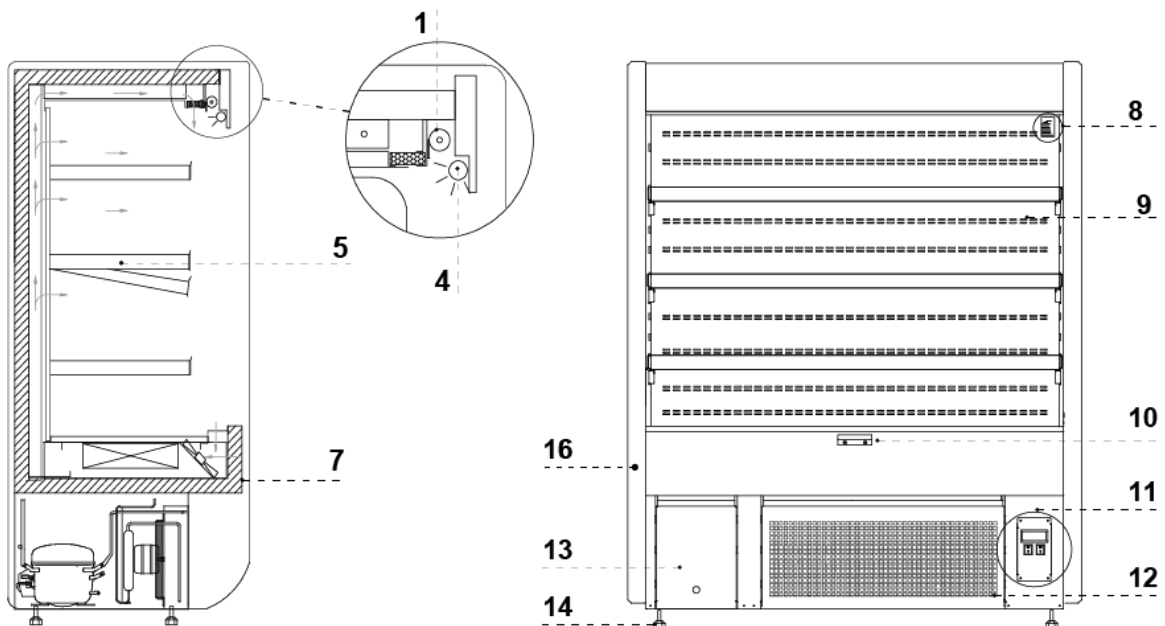

Figure 2 "6OM" overview



- 1 – Night Curtain
- 2 – Upper panel lighting
- 3 – Upper panel plexi-glass
- 4 – Upper lighting- internal
- 5 – Display shelf- Possibility to change height and angle
- 6 – Front bumper
- 7 – Front panel
- 8 – Serial plate
- 9 – Rack screen – **DO NOT block ventilation holes.**

- 10 – Curtain handle
- 11 – Control panel
- 12 – Condenser cover– **DO NOT block the air louver**
- 13 – Access for evaporation Tray
- 14 – Leveling legs
- 15 – ABS sides with glass
- 16 – Painted steel sides

2.3. Technical data

Table 1 Technical data -3OM

Model	Voltage [V/Hz/Ph]	Rated Current [A]	Max shelf load [lbs./kg]	Weight [lbs./kg]
3OM3	115/60/1	15 (max.fuse:20)	73/33	260/120
3OM4	115/60/1	15 (max.fuse:20)	73/33	310/140
3OM5	115/220/60/1	11 (max.fuse:15)	73/33	350/160
3OM6	115/220/60/1	11 (max.fuse:15)	73/33	420/190
3OM8	115/220/60/1	11 (max.fuse:15)	73/33	490/222

Table 2 Technical data -6OM

Model	Voltage [V/Hz/Ph]	Rated Current [A]	Max shelf load [lbs./kg]	Weight [lbs./kg]
6OM3	115/60/1	15 (max.fuse:20)	73/33	310/140
6OM4	115/60/1	15 (max.fuse:20)	73/33	360/163
6OM5	115/220/60/1	11 (max.fuse:15)	73/33	400/181
6OM6	115/220/60/1	11 (max.fuse:15)	73/33	470/213
6OM8	115/220/60/1	11 (max.fuse:15)	73/33	540/244

3. PREPARING THE DEVICE FOR START UP

The unit must be properly installed and located in accordance with the installation instructions before it is used.

3.1. Installation requirements

- Always use a dedicated circuit with the amperage stated on the unit.
- Plug into an outlet designed for the plug.
- Do not overload the circuit.
- Do not use extension cords.
- Never use adapters.
- Never plug in more than one unit per electric circuit.
- If in doubt, call an electrician.

IGLOO will not warranty any equipment that is connected to an extension cord or adapter plug.

The equipment may be turned on after confirmation of the fire protection efficiency with results of measures performed according to binding regulations!

■ **NEMA Plugs**
 IGLOO refrigeration uses this type of plug. If you do not have the right outlet, have a certified electrician install the correct power source.



115/60/1
 NEMA-5-20R
For models: 3OM3, 3OM4, 6OM3 & 6OM4

Figure 3 Permanent connection

For models: 3OM5, 3OM6, 3OM8, 6OM5, 6OM6, & 6OM8

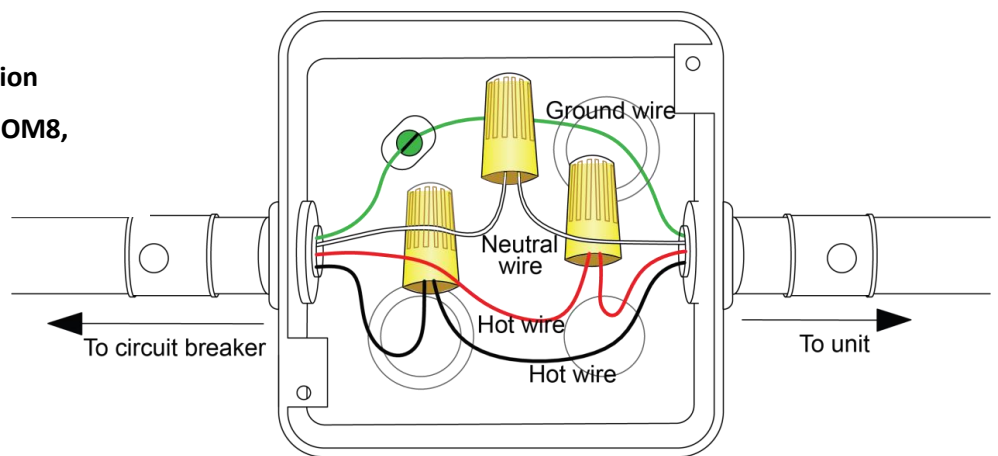

3.2. Unit Location

- Install the unit on a strong and leveled surface.
- To ensure proper operation the unit must be leveled from front to back and left to right.
- Unit may malfunction if improperly leveled.
- Be sure there is sufficient ventilation around the entire unit.
- Select a location away from heat and moisture generating equipment.
- Avoid installation in a high ambient or humid location.
- High ambient temperatures will cause the compressor to overwork.
- Humidity may cause rust, condensation around glass or stainless steel and decrease the efficiency of the unit.

3.3. Connection and start-up

- Remove the protection foil from the elements of the unit (e.g. from the inside of the unit, display shelves, front bumper).
- To securely transport the equipment, the unit may be shipped partially disassembled. If the user received the unit partially disassembled, perform the following operations:
 1. Fix hooks in frame rails. (Figure 4)
 2. Place shelves on hooks. (Figure 5)
 3. Plug in the light cord. (Figure 6)

4. Place the condensate container on the base of the unit, under water outflow hose. (Figure 9)
- The equipment should be cleaned right after unpacking and before turning it on. The unit should be cleaned with warm water not exceeding 40°C with a neutral detergent. For washing and cleaning the equipment, it is prohibited to use products containing chlorine and sodium varieties, which destroy the protective layer and components of the equipment! Any residue of adhesives or silicone on metal elements should be removed only with extraction naphtha (not applicable to items made of plastic). Do not use other organic solvents.

When cleaning the unit, do not use water jet. The unit should be cleaned with a moist cloth.

After installation of the equipment at the destination location it should be left to rest for at least 2 hours before turning it on (for devices with built-in compressor) to set the level of refrigerant in order to prevent problems with the start up.
WARNING: Keep the cooling circuit away from damage!

- Turn on the main switch. (Figure 7/1)
- The temperature on the thermostat control panel is PRE SET. (Figure 7/3)
- Turn on the light switch. (Figure 7/2)

Figure 4 Fixing the hook in the frame

- 1 – Rack screen
- 2 – Hook fixing frame
- 3 – Hook (adjustable to three different angles)

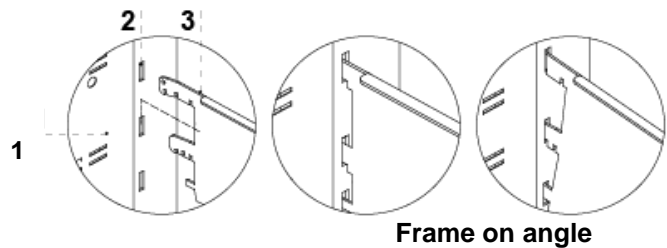

Figure 5 Rack shelf set

- 1 – Shelf hook
- 2 – Element securing the shelf against shifting
- 3 – Rack shelf

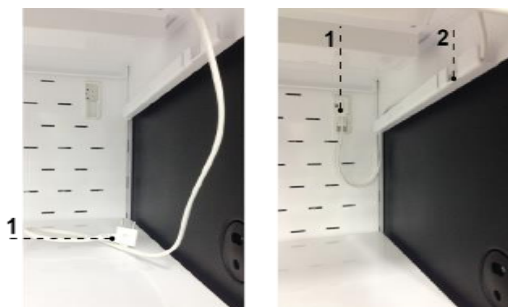
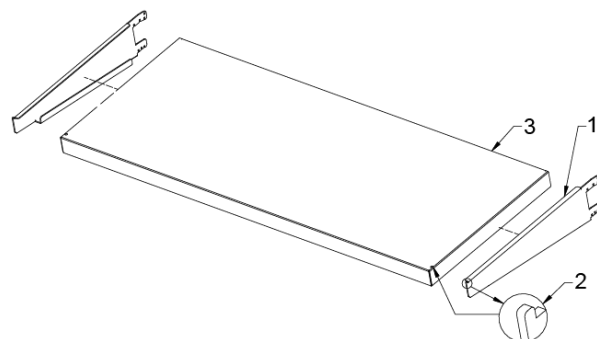
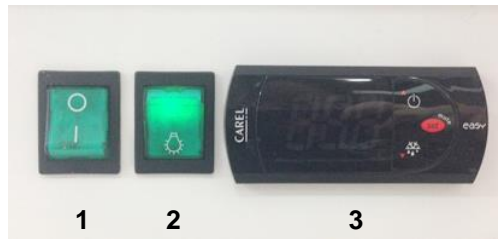

Figure 6 Light plug

- 1 – Plug in the electrical cord into the wall socket
- 2 – Organize the cord as it appeared in the picture

Figure 7 Control panel

- 1 - Main switch (turns on/off the unit)
- 2 - Light switch
- 3 - Thermostat (temperature regulator) panel (Service details in Chapter 4)



4. UNIT START UP

The temperature of the cooled space and aggregate operating cycle may fluctuate. This depends on numerous factors, such as the amount and temperature of the products placed in the device and temperature of the surroundings. The equipment should be placed in a dry and well-ventilated place, ensuring proper air exchange (distance between the wall and the equipment– min. 10cm), out of sunlight, kept far from heat sources and devices enforcing air flow (ceiling and portable ventilators, blow-in heaters). The equipment functions properly in a room, where temperature falls within appropriate climatic class. The operation of the unit may worsen when it is operated in a temperature lower or higher than the stated temperature range.

Remarks and indications

- ***It is necessary to properly level the rack, which will prevent the equipment from noisy operation and will ensure proper water (condensate) outflow during defrosting.***
- ***After transporting the equipment, wait about 2 hours before the startup of the unit.***
- ***To ensure proper conditions for the stored products, do not load the shelves completely. Ensure even load of shelves and not to exceed the maximum load.***
- ***The first filling of shelves should be performed after the unit has reached the desired cooling temperature. This principle should also be observed after long pause in operation.***
- ***Do not block any ventilation holes, which would hamper the circulation of the cooled air (Do not place the products directly to the screen!). It is also necessary to ensure proper airflow around the equipment.***
- ***Keep the condenser clean. Impurities may lead to overheating of the compressor and may result in damages, which is not covered by the warranty.***

- **Do not use electric devices inside the product storing chamber.**
- **When the rack is used without the need to display goods (night work; closed post, shop) it is recommended to drop the roller blinds in order to reduce consumption of electricity.**

4.1. Temperature regulation

The thermostat is to obtain the set temperature within the equipment and maintain it within the determined temperature ranges. The manufacturer enters all settings of temperature regulators required for normal functioning of the equipment. Before primary actuation the user should control and possibly set the required temperature inside the equipment on the control panel.

Digital display – displays the current temperature inside the equipment

It is forbidden to interfere with systemic parameters of the thermostat, as this can lead to serious consequences, including damages to the cooling unit!

Figure 8 “Carel” thermostat control panel

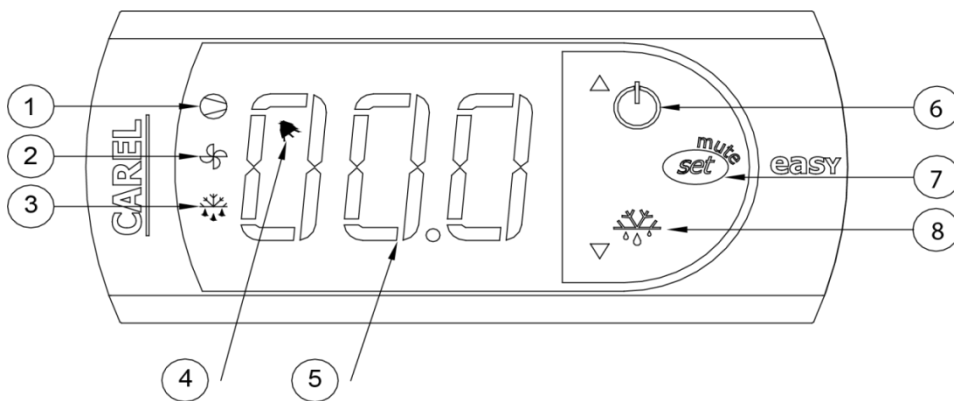

WHAT DO DIODES ON CONTROL PANEL SIGNIFY





- Diode 1 - Compressor:** This symbol is visible when the compressor is working. It is blinking when compressor actuation is delayed by security procedure. It blinks in the following cycle: two blinks – pause, when the constant working mode is activated.
- Diode 2 - Ventilator:** This symbol is visible when evaporator ventilators are turned on. It blinks when the actuation of the ventilators is delayed by external disengagement or when another procedure is in progress.
- Diode 3 - Defrosting:** This symbol is visible when the defrosting function is activated. It blinks when the actuation is delayed by external disengagement or when another procedure is in progress.
- Diode 4 - Alarm:** This symbol is visible when the alarm is activated.
- Diode 5 - Current temperature** inside the equipment is displayed (decimal places displayed after the comma).

Diode 6 – On/Off Switch: Pressing this button alone: for more than 3 sec. switch On/Off, **Pressing with other buttons:** pressed together with 8 activities/deactivates the continuous cycle.

Diode 7 – Set/ Mute: **Pressing this button alone:** 1 sec. displays /sets the set point, more than 3 sec. accesses the parameter setting menu (enter password 22), mutes the audible alarm (buzzer), **Start Up:** hold the set/mute button for 1 sec. RESET current EY set / Pressed together (7 and 8) activate parameter reset procedure.

Diode 8 – Defrost: **Pressing this button alone:** more than 3 sec. activates/deactivates the defrost. **Pressing with other buttons:** pressed together with 6 activates/deactivates the continuous cycle, **Start Up:** hold for 1 sec. displays firmware version.

SETTING THE DESIRED TEMPERATURE

- Press the set button  for 1 second leading value shall be displayed on the screen
- Increase or decrease the leading value by means of  and , until the desired value shall be obtained;
- Press the set button  once again in order to confirm the new value of the setting point.

MANUAL INPUT OF THE DEFROSTING CYCLE

Defrosting shall be released in an automatic mode. It is possible to force defrosting at any moment by pressing and holding the  defrost switch for minimum 5 seconds.

Table 3 Table of alarms and signals

alarm code	buzzer and alarm relay	LED	alarm description	reset
E0	active	ON	probe 1 error= control	automatic
E1	active	ON	probe 2 error= defrost	automatic
E2	active	ON	probe 3 error= condenser/product	automatic
EE	active	ON	unit parameter error	not possible
EF	active	ON	operating parameter error	manual
Ed	not active	ON	defrost ended by timeout	On first defrost ended correctly
CHt	active	ON	dirty condenser alarm	manual

MODIFYING THE PARAMETERS

Parameter navigation

The operating parameters, modifiable using the keypad, are divided into two types: frequent (type F) and configuration (type C). Access to the latter is protected by password (default= 22) to prevent accidental or unauthorized modifications.

Accessing the type F parameters:

- Press the SET button for more than 3 s (if there are active alarms, mute the buzzers). The display shows the parameter code 'PS' (password);
- Use the UP and DOWN buttons to scroll the parameters. The LED corresponding to the category of parameters will be on;
- Press SET to display the value associated with the parameter
- Increase or decrease the value using the UP or DOWN button respectively;
- Press SET to temporarily save the new value and display the parameter again;
- Repeat the procedure for any other parameters that need to be modified;
- Press the SET button for more than 3 s to permanently save the parameters and exit the parameter setting procedure.

Table 4 Table of easy compact parameters for Model 3OM and 6OM

Par.	Description	Def.	UOM.	Min	Max
St	set point	2	°C	r1	r2
PS	password	22	-	0	99
/2	probe measurement stability	4	-	1	15
/4	select probe displayed	1	-	1	3
/5	select °C/°F	0	-	0(°C)	1(°F)
/6	disable decimal point	0	-	0	1
/C1	probe 1 offset	0.0	°C	-50.0	50.0
/C2	probe 2 offset	0.0	°C	-50.0	50.0
/C3	probe 3 offset	0.0	°C	-50.0	50.0
rd	control differential	3.0	°C	0	19.0
r1	minimum set point value	0.0	°C	-50.0	r2
r2	maximum set point value	15.0	°C	r1	99
r3	select direct/reverse operation	0	-	0	2
r4	night-time set point delta	0.0	°C	-50	50
c0	compressor and fan start delay on power-up	1	min	0	100
c1	minimum time between consecutive compressor starts	1	min	0	100
c2	minimum compressor off time	0	min	0	100

c3	minimum compressor on time	0	min	0	100
c4	compressor on time with duty setting	50	min	0	100
cc	continuous cycle duration	2	2	0	15
c6	temperature alarm bypass after continuous cycle	2	h	0	15
d0	type of defrost	0	-	0	4
d1	interval between defrosts	6	h	0	199
dt	end defrost temperature set point	12.0	°C	-50	130
dP	maximum defrost duration	40	min	1	199
d4	defrost when switching the instrument on	0	-	0	1
d5	defrost delay on power-up or when enabled by digital input	0	min	0	199
d6	freeze control temperature display during defrost	1	-	0	1
dd	dripping time	2	min	0	15
d8	alarm bypass time after defrost	1	h	0	15
d9	defrost priority over compressor protectors	0	-	0	1
d/	defrost probe reading (2)	-	°C	-	-
dC	time base	0	-	0	1
A0	alarm and fan temperature differential	2.0	°C	-20	+20
AL	absolute/relative temperature for low temperature alarm	0.0	°C	-50	+99
AH	absolute/relative temperature for high temperature alarm	0.0	°C	-50	+99
Ad	temperature alarm delay	0	min	0	199
A4	3rd input configuration	0	-	0	11
A7	digital input alarm delay	0	min	0	199
A8	enable alarm "Ed" (end defrost by timeout)	0	-	0	1
Ac	set point dirty condenser alarm	60	°C	-50	250
AE	dirty condenser alarm differential temperature	3.0	°C	0.1	20
Accd	dirty condenser alarm delay	0	min	0	250
H0	serial address	1	-	0	207
H1	AUX output configuration	0	-	0	2
H2	enable keypad	1	-	0	2
H4	disable buzzer	0	-	0	1
H5	ID code (read-only)	-1	-	1	+199
EZY	restore the Default settings	2	0	0	1

5. MAINTENANCE

- Do not use steel wool, abrasive cleaners, bleach or cleaners containing chlorine or sodium to clean the unit.
- Do not use pressure washer or water-jet to clean the unit.
- The unit should be cleaned right after unpacking and before turning it on.
- The unit should be cleaned with warm water and a mild soap.
- Make sure to cover the fan motor to prevent moisture damage.
- Door gaskets, shelves and supports should be cleaned on a regular basis.
- Fan blades and guards should be cleaned with a soft cloth.

5.1 Cleaning and maintenance

- ***All maintenance services need to be performed after disconnecting the equipment from power supply!***
- ***Protect electrical components against any damages or water spillage.***
- ***Do not use water stream to clean the equipment, only a moist cloth.***
- ***Do not use any sharp objects to remove dirt!***

Figure 9 Cleaning the condenser

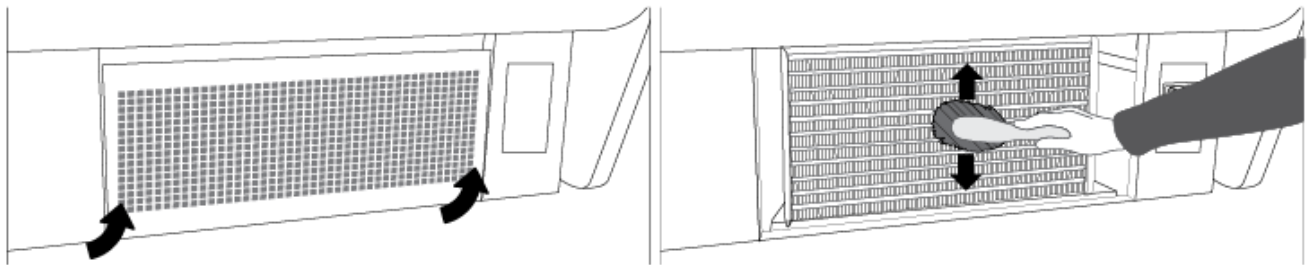

It is essential to keep the condenser of the device clean. Dirt may hinder the heat exchange, causing an increase in electricity consumption and may cause damage to the compressor. In order to clean the condenser it is necessary to unscrew the sheet metal screws and pull the wind brace out of catch by lifting it up. Clean condenser lamellas with help of soft brush or paint brush. If the condenser is extremely dirty (blocking of lamellas), use vacuum cleaner or compressed nitrogen to remove dirt from between lamellas.

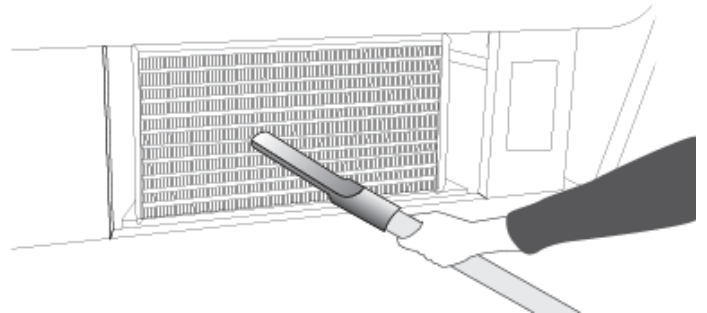

The seller shall not be held responsible for damages to the condenser unit in the case of non-observance of the condenser cleaning instructions.

Do not use mechanical agents to quicken the defrosting process!

6. SERVICE

6.1. Faults identification and repair

In case of any difficulties during actuation of the unit or during its operation, please return to the chapters in this manual, which explain the performed operation. This aims to ensure the equipment is properly operated. If you still experience difficulties, the following might help you solve the problem.

The equipment is not working... – Make sure that:

- The equipment is connected to the power supply.
- Voltage and frequency are compliant with those recommended by the manufacturer, 115V/60Hz or 115V/220V/60Hz.
- The main switch is turned on.
- Thermostat is turned on.

The equipment is operating, but the light is off... – Make sure that:

- Light switch is turned on.
- Lamp, starting switch, or power supply of the unit is not burnt.

Water leakage from under the device:

- Check whether the equipment is properly levelled.
- Empty the condensate container.

The equipment does not reach the proper temperature, the light is on... – Make sure that:

- The main switch is turned on.
- Temperature setting on the thermostat is properly set.
- Thermostat works properly.
- The condenser is clean, if necessary – clean the condenser.
- Ambient temperature does not exceed 25°C.
- Enough time has passed for products to be cooled.
- Ventilation holes are not blocked.

The equipment is working too loud...– Make sure that:

- The equipment is standing stably and is properly levelled.
- Furniture adjoining the equipment does not vibrate when self-contained compressor is working.

Noises made by the operating device is a normal phenomenon. The units are equipped with ventilators, engines and compressors, which turn on and off automatically. Each compressor makes certain noises when operating. These sounds are made by the aggregate engine and by cooling agent flowing through the circuit. This phenomenon constitutes a technical feature of cooling devices and does not signify equipment failure.

Steam precipitation on glasses is a normal phenomenon in the event of high relative air humidity exceeding 60% and does not require calling for service.

6.2 Service

IGLOO Refrigeration service

Telephone number: 416-663-3051 or (toll free) 1-888-408-8819

E-mail: service@igloo400.com

If after checking points described in chapter 6.1 “Faults identification and repair” and the unit still does not work properly,

Please contact Technical Service @ IGLOO Refrigeration.